

Topsy Turvy

Designed by David Mitchell

Topsy Turvy was designed in 2005 for my book Office Origami (published under a pseudonym) for which the publishers had requested edge designs and words. Some of the designs, and words, proved too edgy for the American publisher involved but this one survived the editorial biro, although its title was changed to the Naughty Elephant.

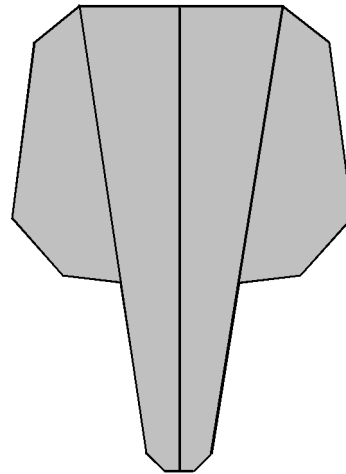

Topsy Turvy is indeed an elephant, but one that can be turned upside down, or rather, of course, topsy turvy, to give your Boss, or anyone else you dislike, the finger. It is based on a two piece elephant, called Jum-bo, which I had designed much earlier in 1989.

You can fold Topsy Turvy from any kind of paper. If you are using irogami begin with your paper arranged white side up.

1

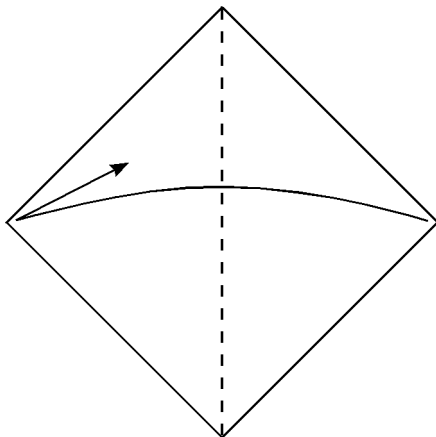

1. Fold in half from right to left, crease firmly, then unfold.

2

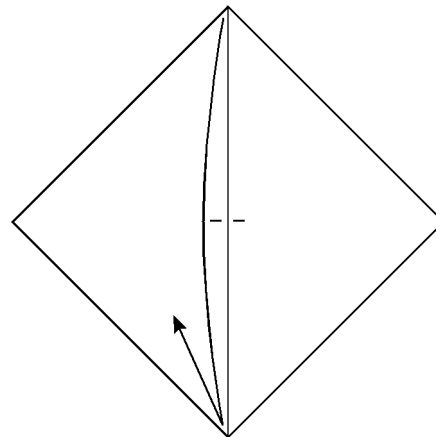

2. Fold in half from top to bottom making only the tiniest of creases, then unfold.

3

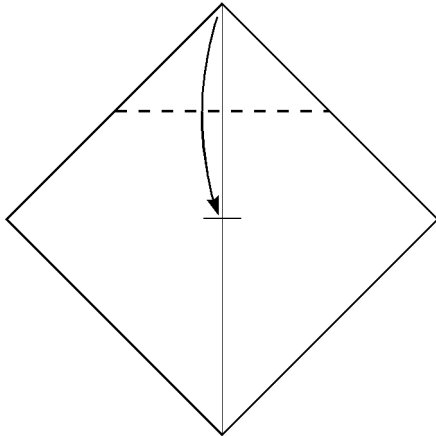

3. Fold the top corner downwards using the intersection of the creases made in steps 1 and 2 to locate the fold.

4

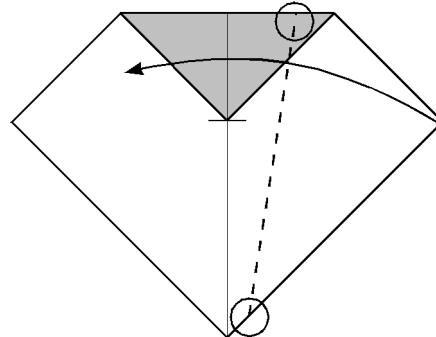

4. Fold the right hand corner across to the left. There are no location points for this fold which must be made by eye alone. Picture 7 shows what the result should look like.

5

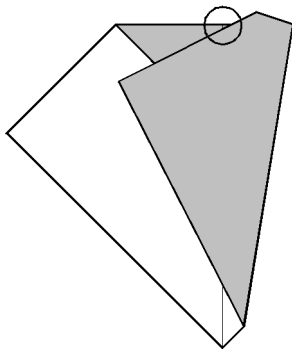

5. Turn over sideways.

6

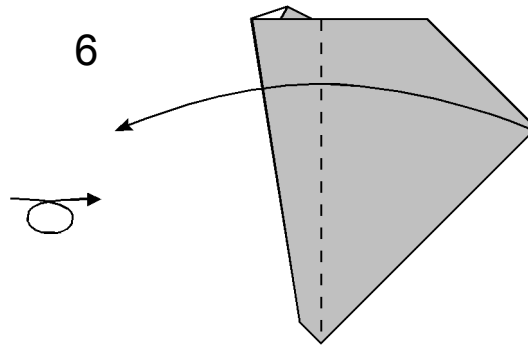

6. Fold the right hand corner across to the left by reversing the direction of the existing crease.

7

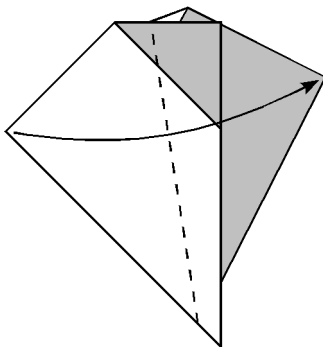

7. Fold the left hand corner across to the right so that the edges of the front and back flaps line up exactly.

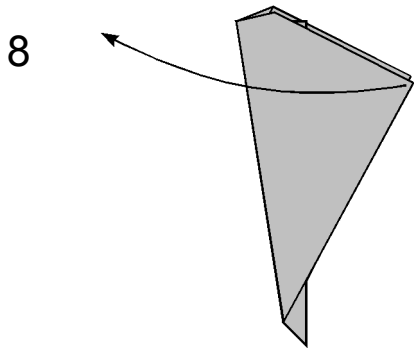

8. Undo folds 6 and 7 and return the paper to the alignment shown in picture 5.

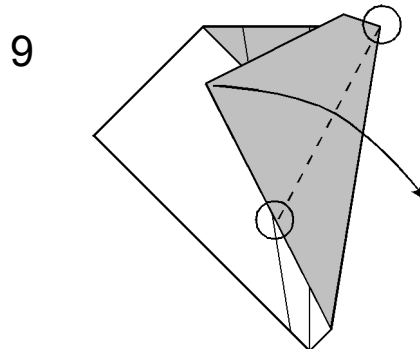

9. Fold the point of the front layer out to the right. The circles show you how to locate the fold.

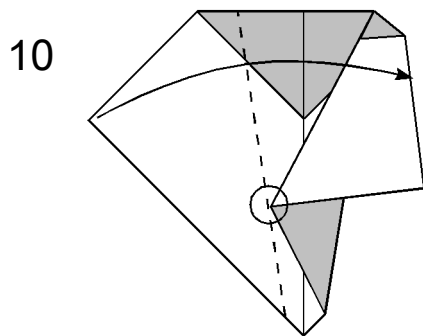

10. Fold the left hand point back across to the right using the existing crease.

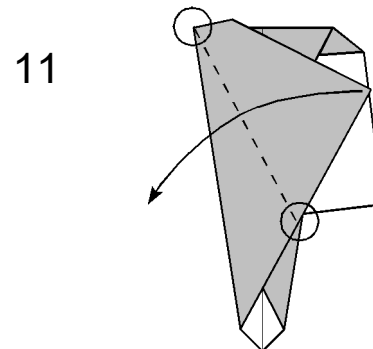

11. Fold the point of the front layer out to the left. This is a repeat of step 9. Try to maintain the symmetry of the design as you make this fold.

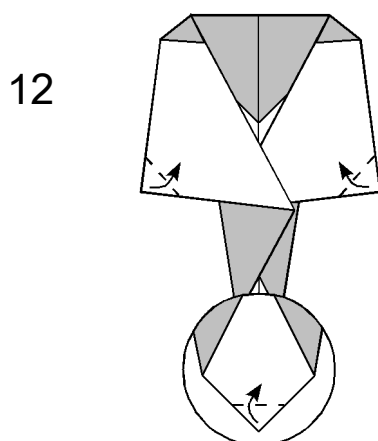

12. Make these three small folds to round off the ears and the tip of the trunk.

13

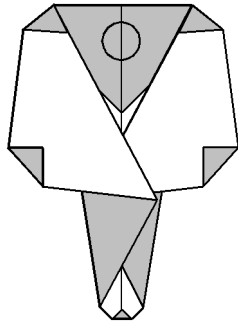

13. Gently release the flap marked with a circle from the other layers and lift it up towards you at right angles.

14

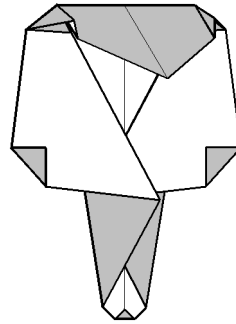

14. Topsy is finished. Turn over sideways.

15

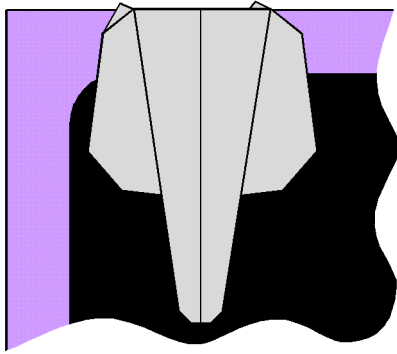

15. Use the flap to hang Topsy from a suitable shelf, box or VDU screen.

16

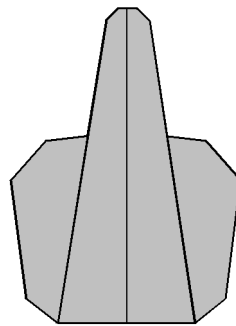

16. Topsy has been known to turn Turvy when the boss walks past.

Copyright David Mitchell 2016
www.origamiheaven.com