

The Photo Frame Cube

Designed by David Mitchell
and Francis Ow

The Photo Frame Cube is so named because each face looks rather like an old-fashioned photo frame with triangular pockets at each corner to secure the photo in place.

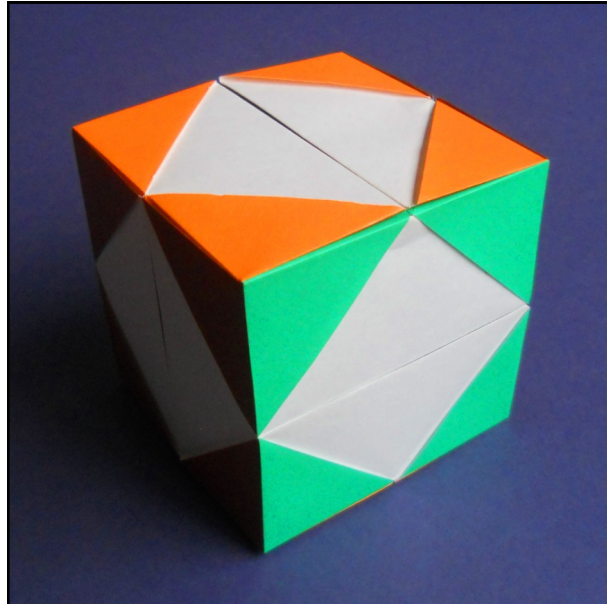

I discovered this cube for myself in 1989, then, in October 1990, Francis Ow kindly sent me a copy of his then just-published book, *Modular Origami*, in which the same design appears, under the rather prosaic title of *Cube 3*. I do not know which of us has priority in the design.

In revisiting the design in order to draw these diagrams I discovered a second, somewhat simpler, and, perhaps, rather more interesting, method of assembling the modules.

Although the faces of the original version of the cube look as though they will hold photos it is in fact impossible to slide them into place. The revised method does, however, allow this to be done and, in a way therefore, validates the original name.

You will need six squares of paper to make a Photo Frame Cube and another square of the same size to use as a template. The diagrams show the effect of using two squares of irogami in each of three contrasting but complementary colours, but using duo paper will also give an attractive result.

This design will only work well if you make your folds really accurately.

Making a Photo Frame Cube using the original method

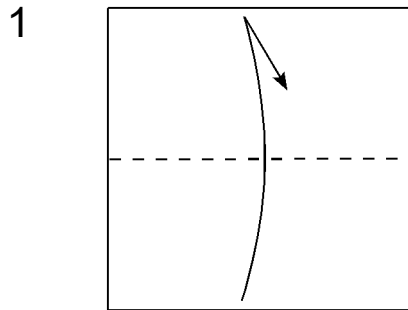

1. Fold the template square in half upwards, crease, then unfold.

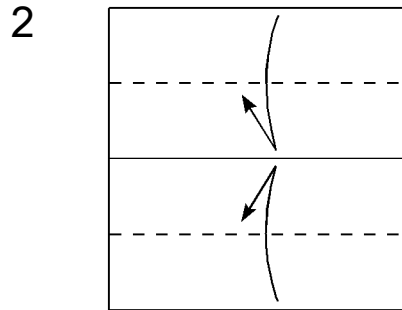

2. Fold both the top and bottom edges to the middle, crease, then unfold.

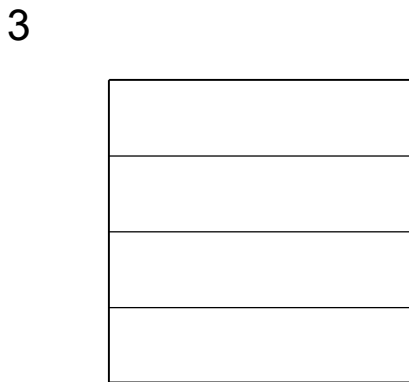

3. The template is finished.

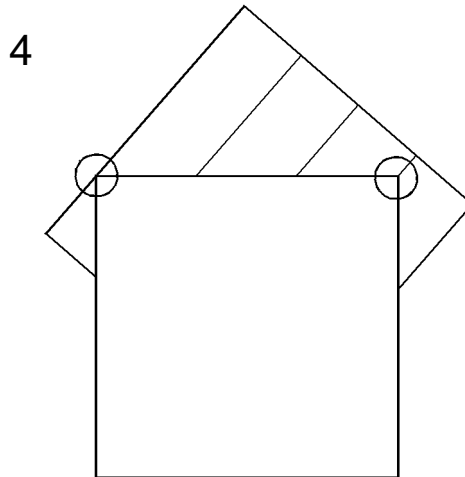

4. Laying the first of your six squares, white side up, on top of the template like this, making sure the corners are aligned to the edge of the template and the crease in the way marked with circles here.

5

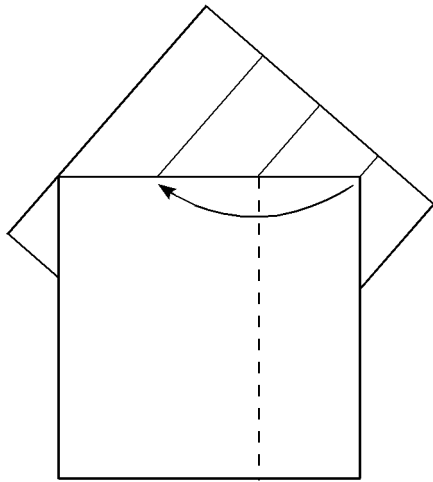

5. Fold the right hand corner inwards as shown. Make sure the two squares don't slip out of alignment as you make this fold.

6

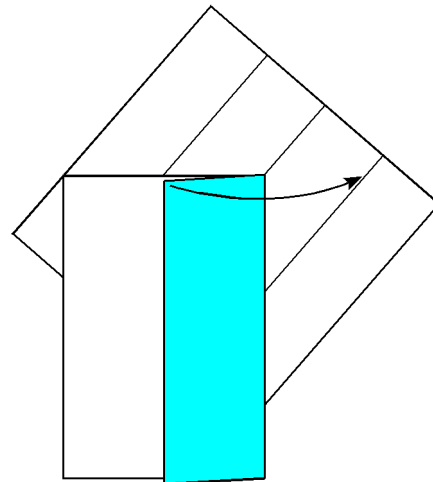

6. Open out the fold made in step 5 and remove the square from the template. Arrange with the crease at the top to look like picture 7.

7

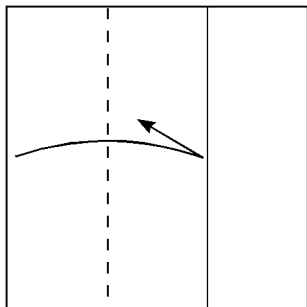

7. Fold the left hand edge onto the crease made in step 5, crease, then unfold.

8

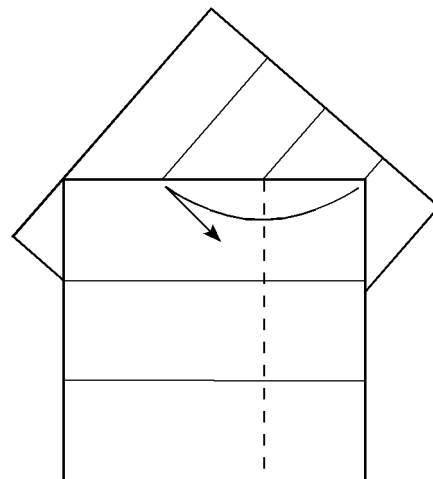

8. Your paper is now divided into thirds. To divide the paper into thirds in the other direction as well, rotate through ninety degrees and repeat steps 4 through 7.

9

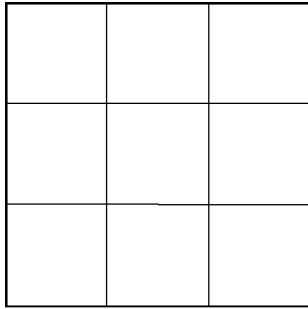

9. Your first square should now look like this.

10

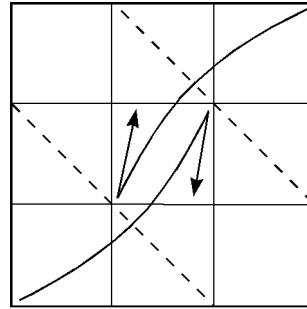

10. Fold the top right and bottom left corners inwards as shown, then unfold, in turn.

11

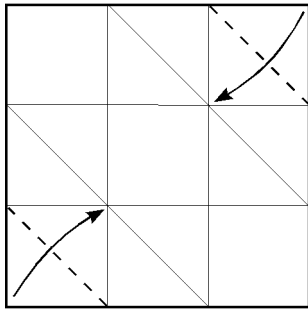

11. Fold the top right and bottom left corner squares in half diagonally inwards like this.

12

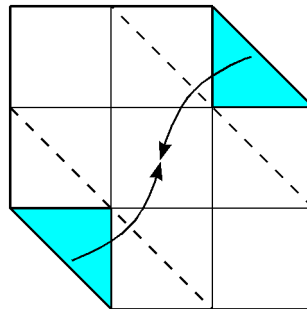

12. Remake the creases made in step 11.

13

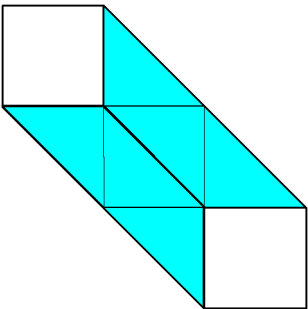

13. Turn over sideways.

14

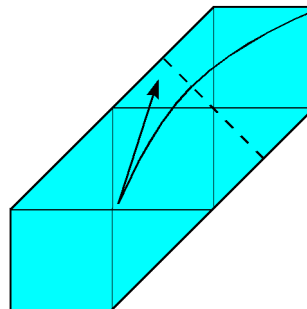

14. Fold the top right corner diagonally inwards like this, then unfold.

15

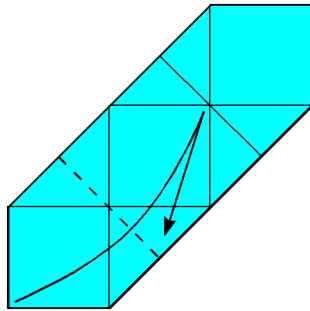

15. Repeat step 14 on the bottom left corner.

16

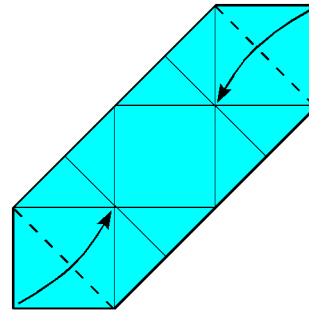

16. Fold both the top right and bottom left corners inwards as shown. These folds create the tabs.

17

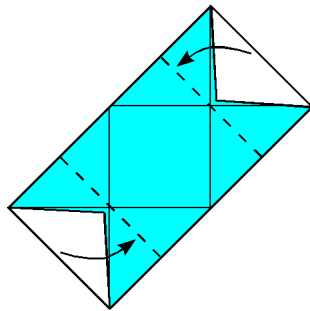

17. Lift both ends up at right angles using the existing creases, then arrange to look like picture 18..

18

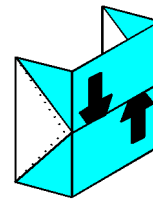

18. The first module is finished. Make all six. The module has two pockets which are indicated by arrows.

19

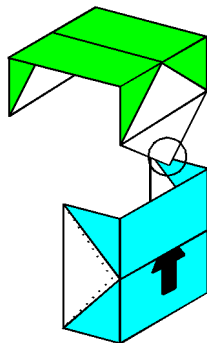

19. Open out the tab at one end of one module and insert it into the upper pocket of a second by folding it back on itself using the existing crease.

20

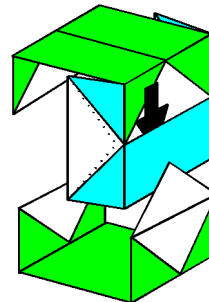

20. Add a third module in a similar way.

21

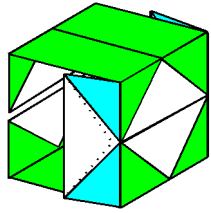

21. One face of the cube is finished.

22

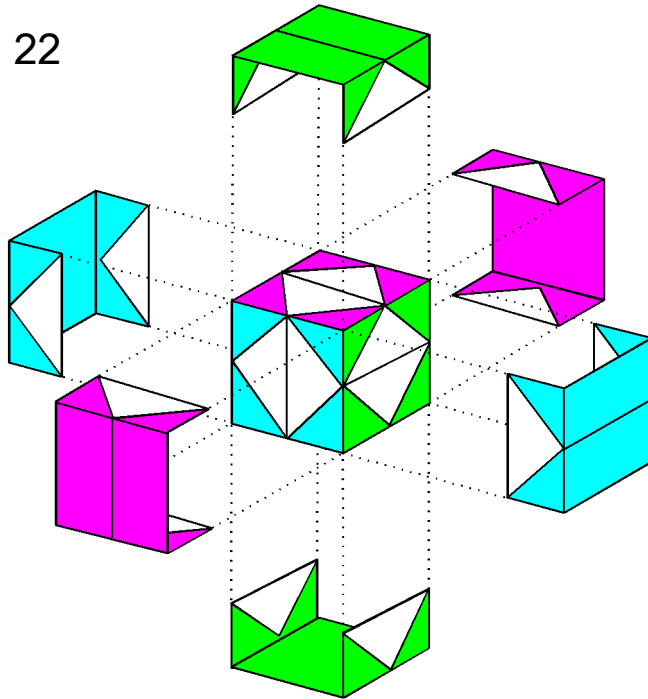

22. Continue adding modules in the same way to complete the other faces, keeping to the pattern of colours shown.

23

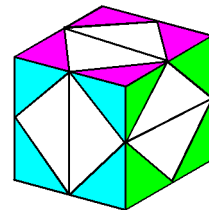

23. The original version of the Photo Frame Cube is finished.

Making a Photo Frame Cube using the revised method

The modules are folded in the same way except that only the top right corner is folded inwards in step 16.

24

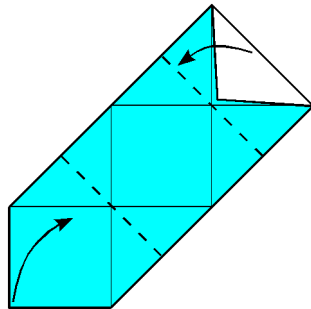

24. Fold both ends up at right angles using the existing creases then arrange to look like picture 25.

25

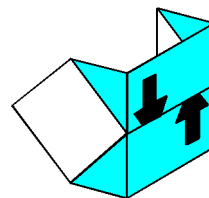

25. The first module is finished. Make all six. The module has two pockets which are indicated by arrows.

26

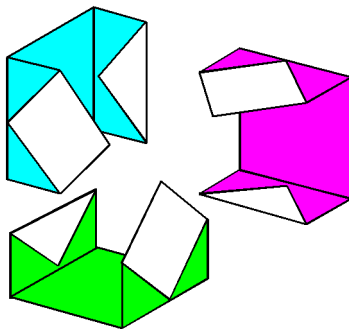

26. Put three modules together to form a corner like this using the original method to link the modules together at the back.

27

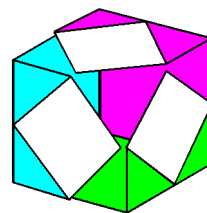

27. The result should look like this.

29

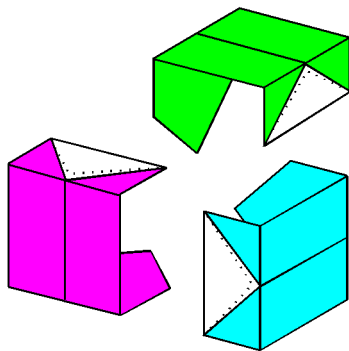

29. Put the other three modules together to form a second corner like this, still using the original method.

28

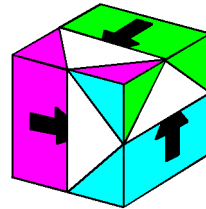

28. The resulting corner will look like this. Put the two corners together to form the cube, making sure that all the remaining tabs are on the outside of the design, then slide each tab in turn into the pocket below it.

28

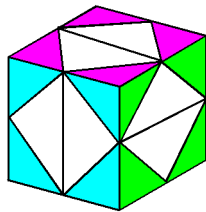

28. The result will look like this. The revised method Photo Frame Cube is finished.

Copyright David Mitchell 2018
www.origamiheaven.com