

Knotfish

Designed by David Mitchell

Knotfish is a simple fish made by adapting the traditional fold known as the Lover's Knot.

I designed Knotfish in 1996

Knotfish is folded from a single square of paper. If you are using irogami begin with your paper arranged coloured side up.

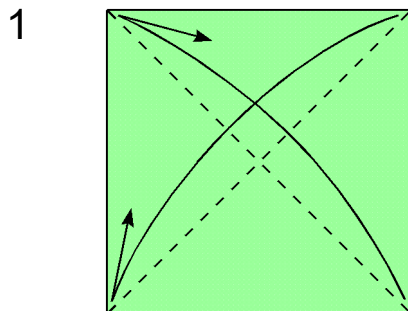
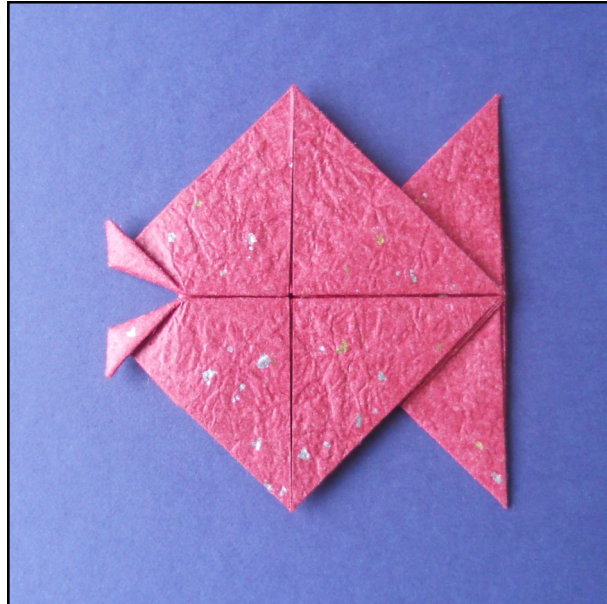

1. Fold in half diagonally, then unfold, in both directions.

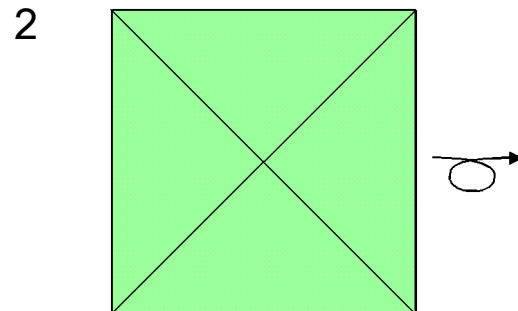

2. Turn over sideways.

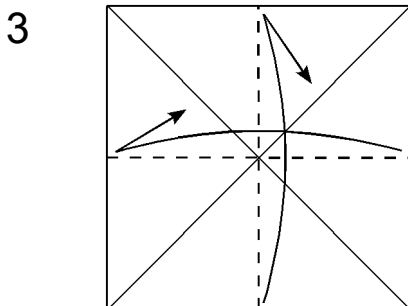

3. Fold in half edge to edge, then unfold, in both directions.

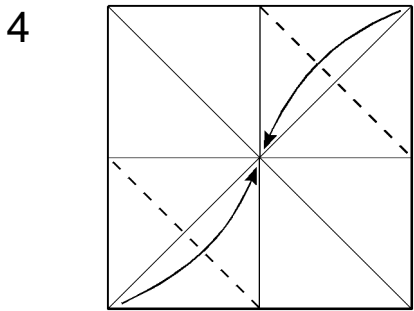

4. Fold two opposite corners to the centre.

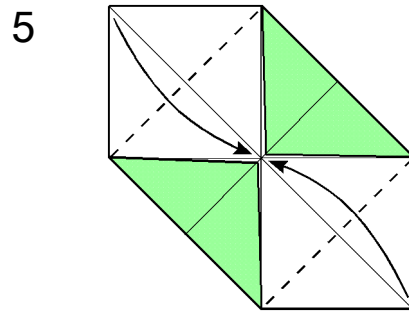

5. Fold the remaining corners to the centre as well.

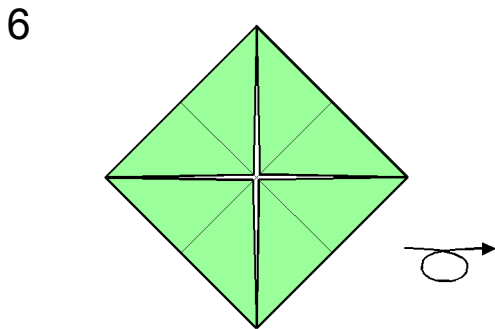

6. Turn over sideways.

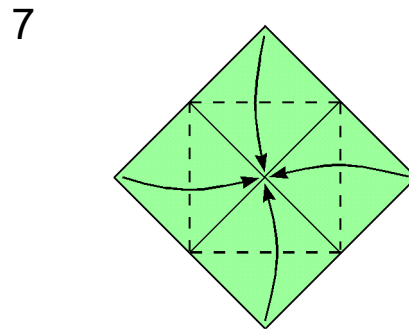

7. Fold all four corners to the centre. Your folds will be more accurate if you fold two opposite corners inwards first.

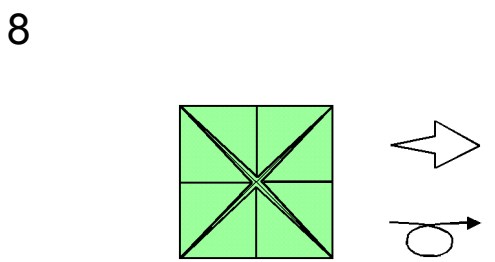

8. Turn over sideways. The next picture is on a larger scale.

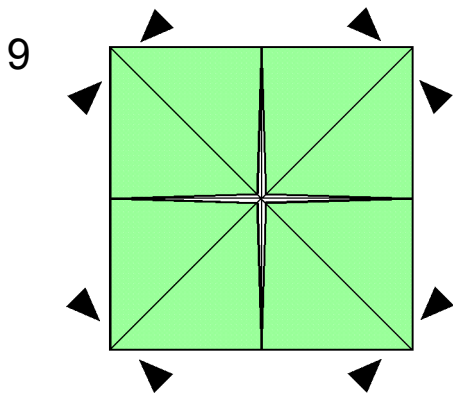

9. Squeeze the corners together. As you do this make sure the front layer moves towards you and the back layers move away. You will need to reverse the direction of the creases in the front layer individually to achieve this.

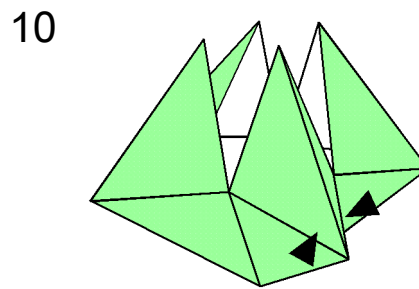

10. This picture shows this move in progress. Squeeze the corners together completely, then flatten the design so that it looks like picture 11.

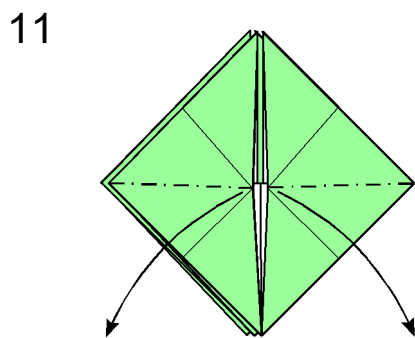

11. Open the front flaps at the centre and squash fold them downwards. Picture 12 shows what the result should look like.

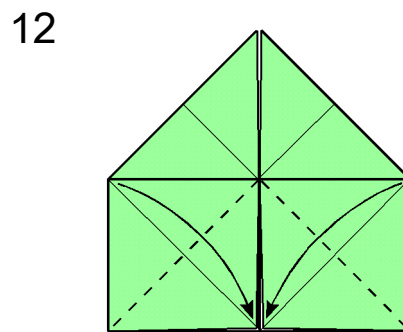

12. Fold the top corners of the front layer inwards as shown. Crease firmly.

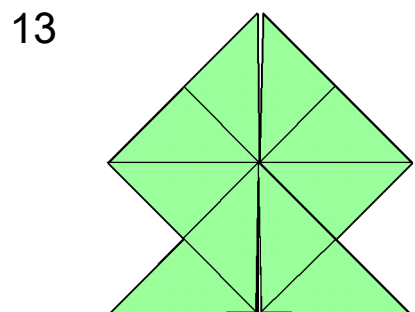

13. Turn over sideways.

14

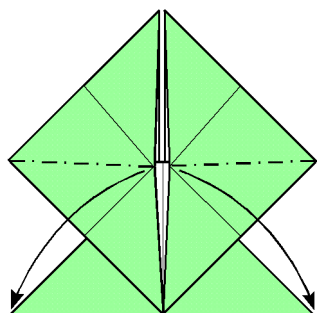

14. Repeat fold 11 on the other half of the paper.

15

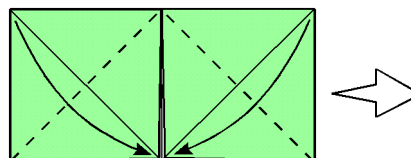

15. Now repeat fold 12 as well. The next picture is on a larger scale.

16

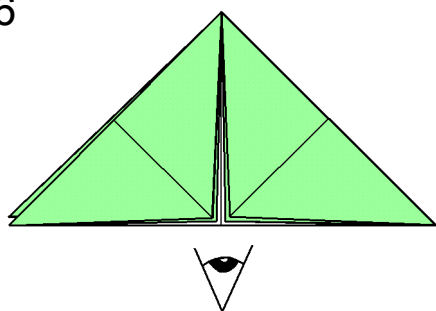

16. The next picture shows the design from a different viewpoint.

17

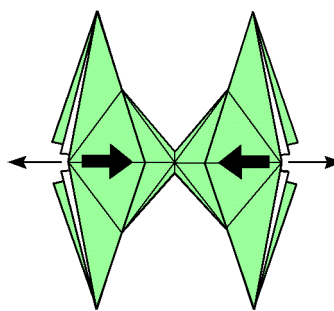

17. Insert your thumbs into the pockets marked with arrows and gently pull them apart

18

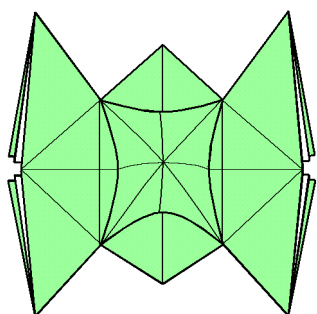

18. As you do this the central spike will flatten. This picture shows the process part way through. Keep flattening the spike until it becomes a completely flat square.

19

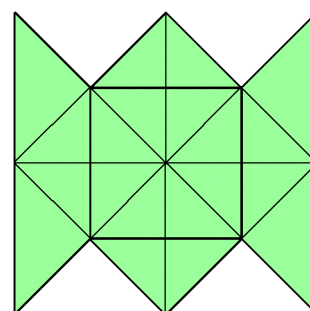

19. The Lover's Knot is finished.

20

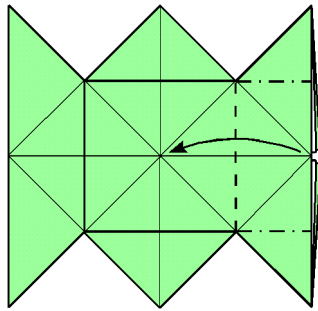

20. Fold the centre of the front two layers of the right hand edge to the left and flatten so that the design looks like picture 21.

21

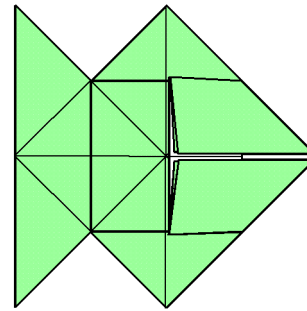

21. The enlargements show how to form the mouth.

22

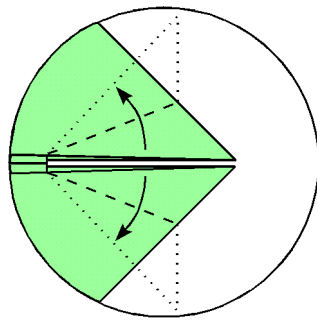

22. Fold the lips upwards and downwards as shown.

23

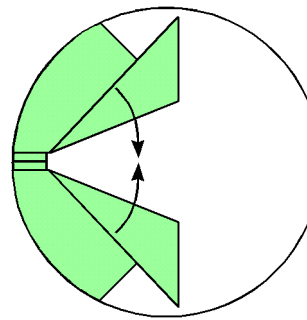

23. Open out the folds made in step 22.

24

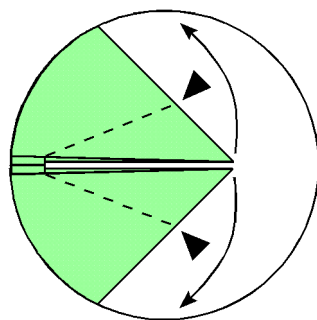

24. Outside reverse fold the lips. You will be able to open out the flaps marked with small circles in picture 25 to make this easier to achieve.

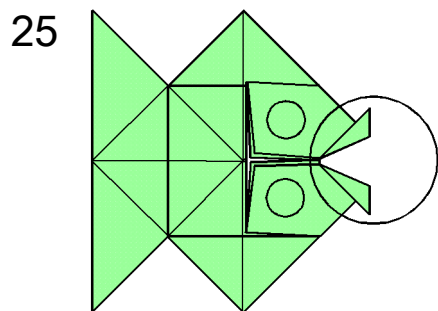

25. Turn over sideways.

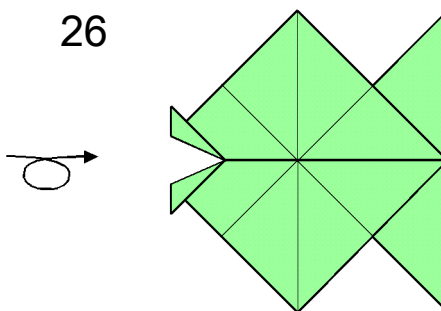

26. Knotfish is finished.

Copyright David Mitchell 2017
www.origamiheaven.com